



SC-130 Hydromill

soilmec
Drilling and Foundation Equipment

The new generation Soilmec hydromill

Combining innovative technology with compact design, the new generation SC-130 hydromill line is designed to be both versatile and reliable.

Two different models to meet any excavation requirement.

SC-130 “Tiger Plus”

Built with a multipurpose design this machine is the perfect choice for the customers that are doing diaphragm wall (DW) in both configuration Grab and Hydromill up to 120 m depth.

SC-130 “Cougar”

Built with a compact design is the perfect choice for the customers who are looking for a hydromill technology dedicated machine covering a vast number of requests, performing panels up to 70 m depth.

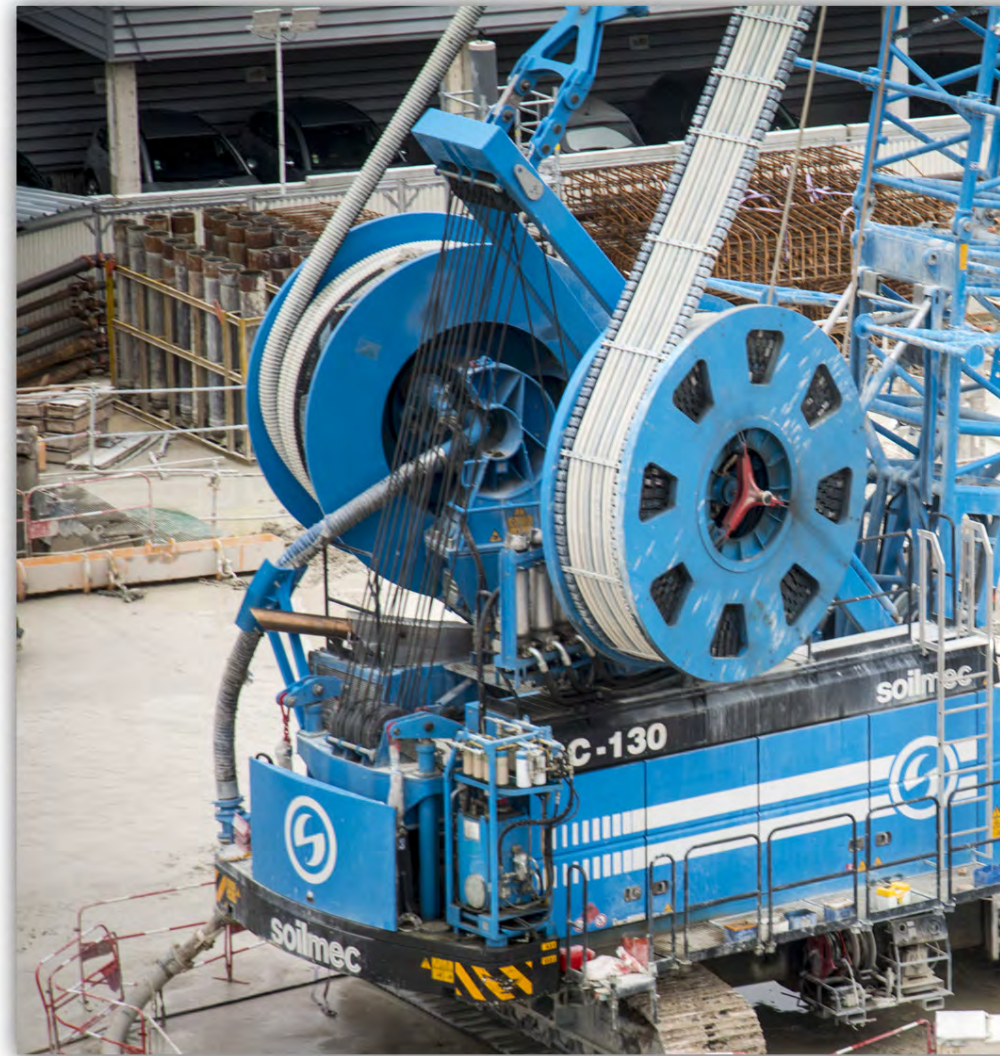



Great reliability

High accuracy filtering system on the main hydromill lines specifically designed to provide better lubrication and protection against contamination to all excavating parts.

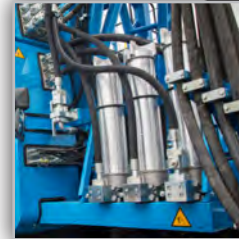

Unparalleled ergonomics

- H-cab with outstanding volume (1050 mm wide).
- Air-suspended & fully adjustable seat with lumbar support.
- Sliding door.
- New air conditioner system.
- TouchScreen & Adjustable monitor 12" for DMS.
- Sunshade shield for cabin.



High level of stability

Robust undercarriage featuring wide tracks and long crawlers. Modular rear counterweight for most difficult applications. Solid upper frame design with optimal weight distribution.

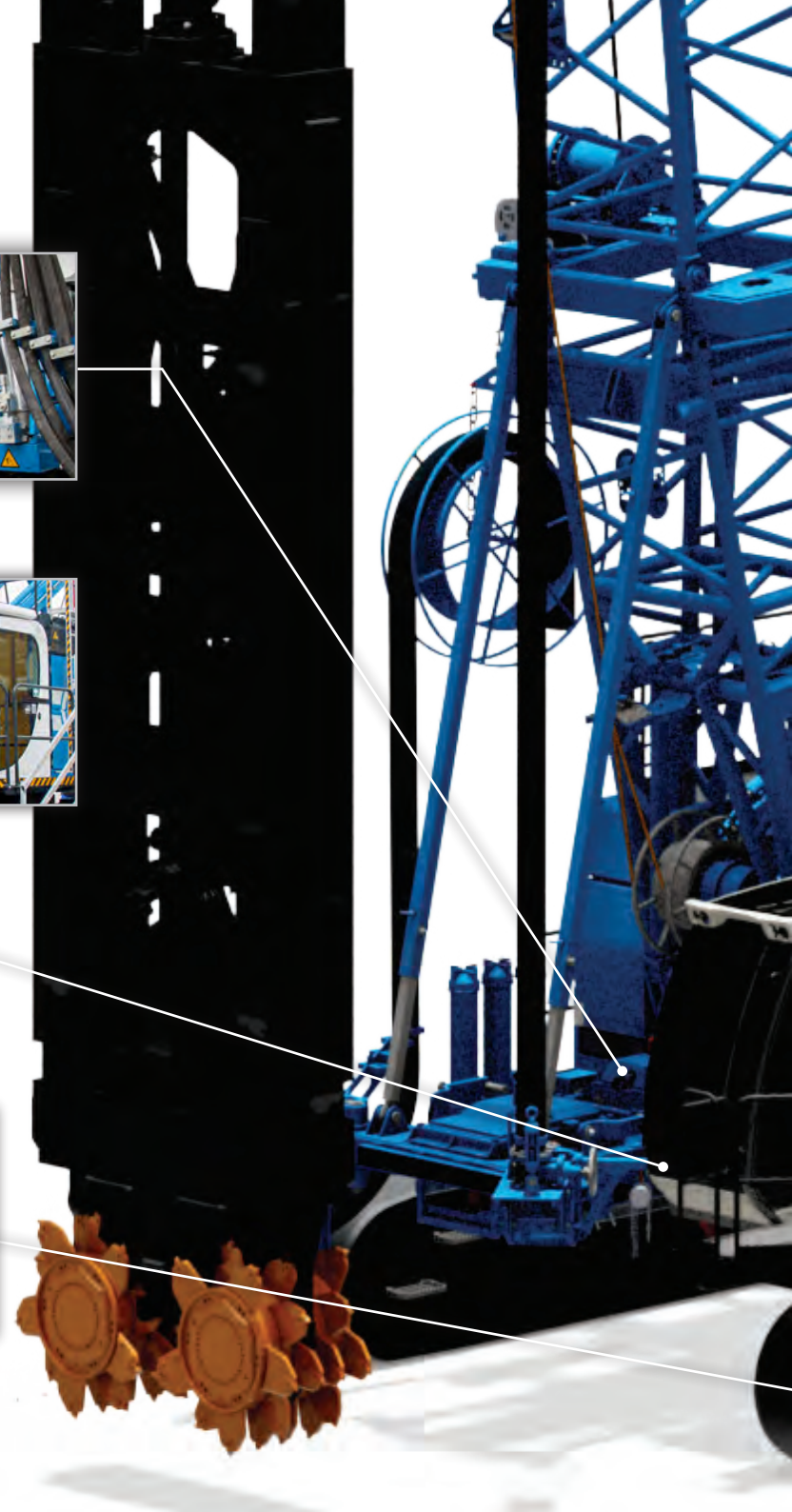



High efficiency

Diesel engine fitted with complete package of innovations including the “start & slow” system and the new heat exchangers design and control and its air flows.

All radiators have an independent control system that automatically adjust the speed according to needs to performs the greatest overall power performance, reducing fuel consumption and noise.

Safety first

Radio remote control for tramming operation, for teeth changing and for rope changing.

Quick assembly catwalk 900 mm width with handrails and stairs to make maintenance activities easy and fast.

Package of 8 cameras with monitor on cab for full awareness of all the surrounding area and winches.

Limit switch for rope winding and winches.

Excavating / Assembly mode assuring the best safety standards for maintenance staff.

Powerfull led lights with antiglare technology.

White sound system - Acoustic & light alarm.

T-panel innovation.

Milling unit with rotation system conceived for T-panel execution or for other module orientation.

This specific features gives the possibility to facilitate the job site operation, leading to a reduction in terms of cost and time.



Well suited for urban development.

The SC-130 hydromills are a perfectly suited to work on construction sites with space constraints and in metropolitan areas with stringent noise pollution requirements.



Hydromill Technology: verticality control at the highest levels



Soilmec Hydromill Verticality Control has been developed in order to reach the best requirements in terms of diaphragm precision, allowing verticality error less than 0,2 % tested up to 250 m depth. Verticality control has been ensured by the means of double or triple axis sensors; for very high depth panels Soilmec defines a special triple axis sensor that guarantees an incredible accuracy for long and deep excavations.

CONSTRUCTION

DMS product suite

Integrated solution embracing smart technology to optimise the use of machinery and increase efficiency on job sites.

Soilmec DMS helps to gain unique insights into ground engineering and DW business by collecting, analysing and managing the most relevant information from the equipment.

The system is intended to support construction companies in daily operations and business processes by improving decision making and leveraging the potential of data analytics.



DMS ON BOARD

Built-in instrumentation for equipment supervision and performance control.



DMS PC

Licensed software for machine and production data processing and reporting.



DMS MANAGER 4.0

Cloud app for asset, fleet and site management.



Hydromill full package

With Soilmec hydromill package you can get a top quality machine, the complete job site equipments & technology and trustworthy working partner.

Our selected team assist from the moment the machine leaves the factory. Professional technicians and operators carry out complete commissioning and assistance, allow you to get your production targets and provide training on site depending on your requirements.

Additionally, our site supervisor assist you with analysis, integration, and development of the construction site.

Whatever your need for DW with hydromill we knowledge and equipment to provide your best

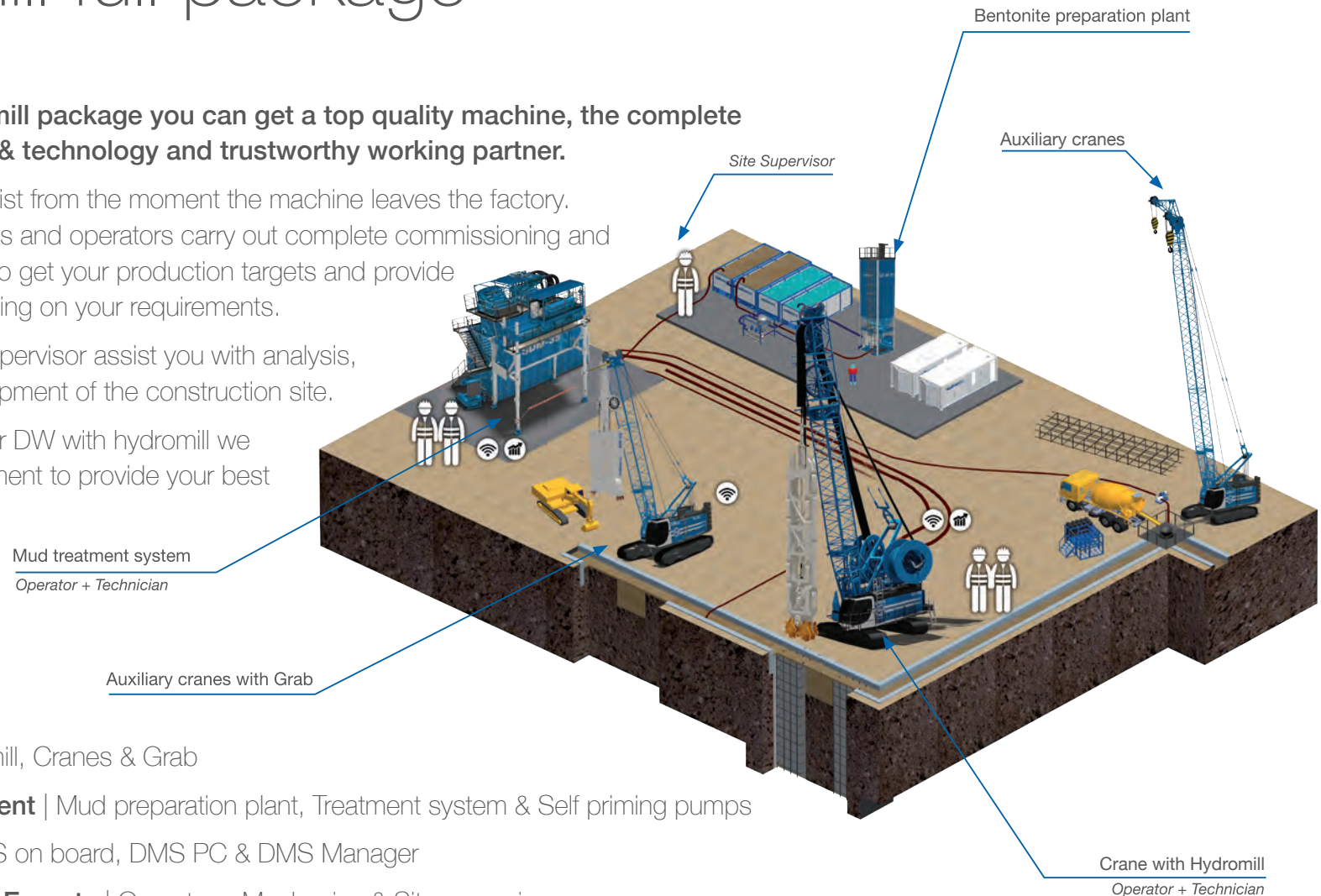

- **Machinery** | Hydromill, Cranes & Grab
- **Ancillaries Equipment** | Mud preparation plant, Treatment system & Self priming pumps
- **Technologies** | DMS on board, DMS PC & DMS Manager
- **Dedicated team of Experts** | Operators, Mechanics & Site supervisor

SC-130 Cougar

The Hose Wheels Design (HWD) is positioned below the cathead so it can easily follow the hydromill movements with a tensioning and rewinding automatic system.

It arises from the need to move simultaneously the hydraulic and bentonite mud circulation hoses to the milling unit.

- 1 UNDERCARRIAGE
- 2 BASE MACHINE
- 3 CAB
- 4 MUD HOSE WHEEL
- 5 HYDRAULIC HOSE WHEEL
- 6 BOOM
- 7 HYDROMILL MODULE
- 8 CUTTING MOTORS AND DRUMS

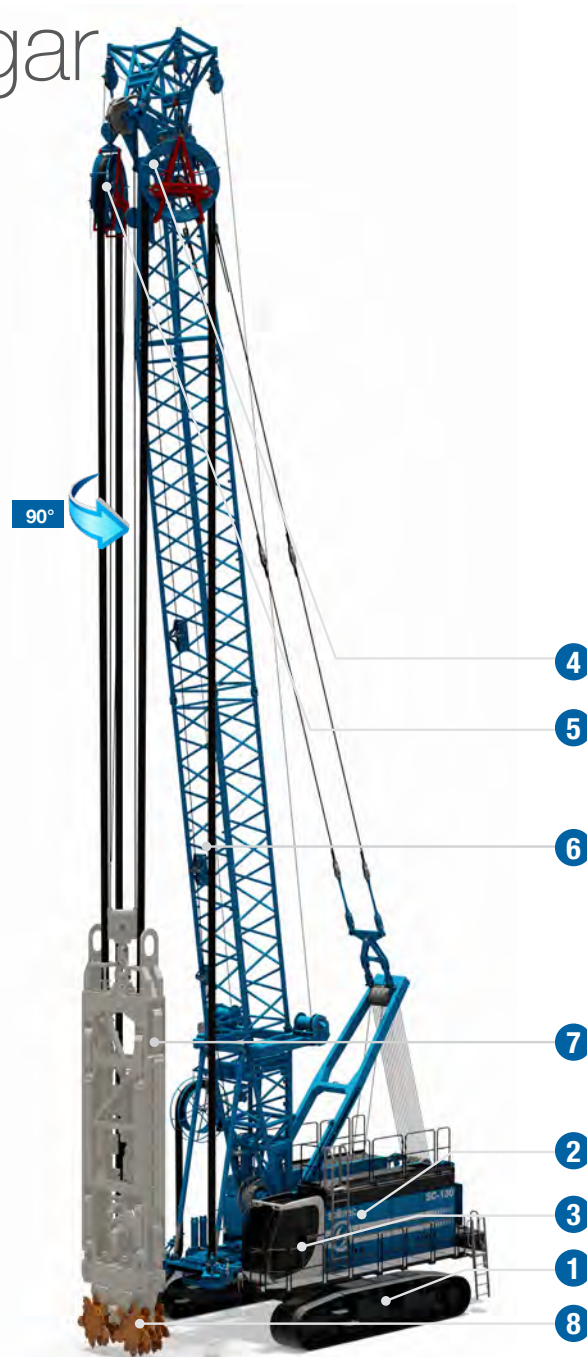

Standard version



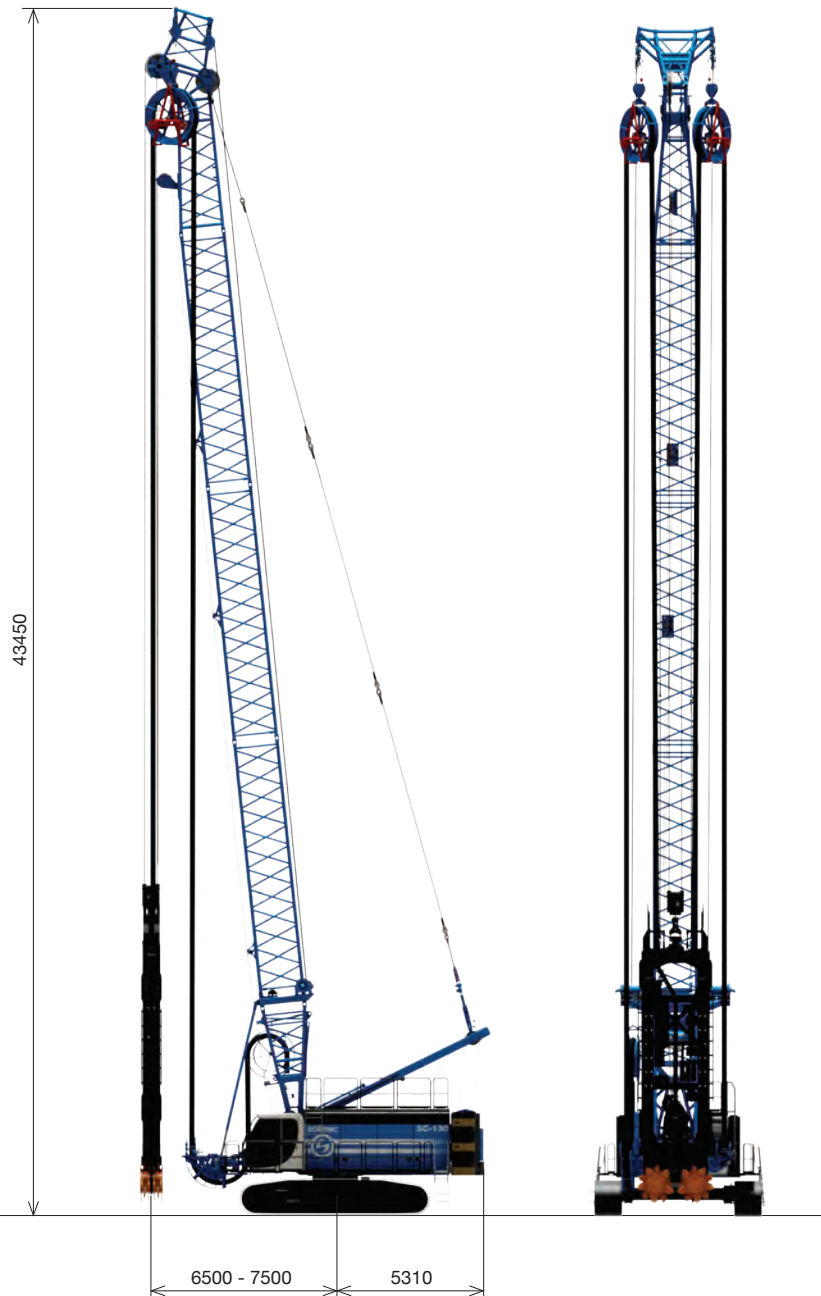

Extended version

SC-130 "Cougar" - standard version

Operating weight	165000 kg	363762 lb
Max cutting depth	52 m	171 ft
Milling unit	SH-30 / SH-40	SH-30 / SH-40
Module rotation	0 - 90°	0 - 90°
Operating height	34,3 m	113 ft
Boom length	29,5 m	97 ft
Working radius	6000 - 8000 mm	236 - 315 in
Min operating length (tail - excavation center)	11310 mm	445 in
Counterweight	35800 kg	78925 lb

SC-130 "Cougar" - extended version

Operating weight	175000 kg	385809 lb
Max cutting depth	70 m	230 ft
Milling unit	SH-30 / SH-40	SH-30 / SH-40
Module rotation	0 - 90°	0 - 90°
Operating height	43,4 m	142 ft
Boom length	38,5 m	126 ft
Working radius	6500 - 7500 mm	256 - 295 in
Min operating length (tail - excavation center)	11810 mm	465 in
Counterweight	42000 kg	92594 lb

SC-130 Tiger Plus

With the aim of meeting the need for increased diaphragm wall depth in the most challenging soil conditions, Soilmec has designed the “HDD” (Hose Drums Design) hydromill configuration.

Hydraulic and mud winders are positioned on a base carrier, allowing high depth drilling performances.

Multipurpose diaphragm wall equipment.

The SC-130 Tiger Plus can be equipped in three different versions: **Hydromill**, **Hydraulic Grab** or **Mechanical Grab**

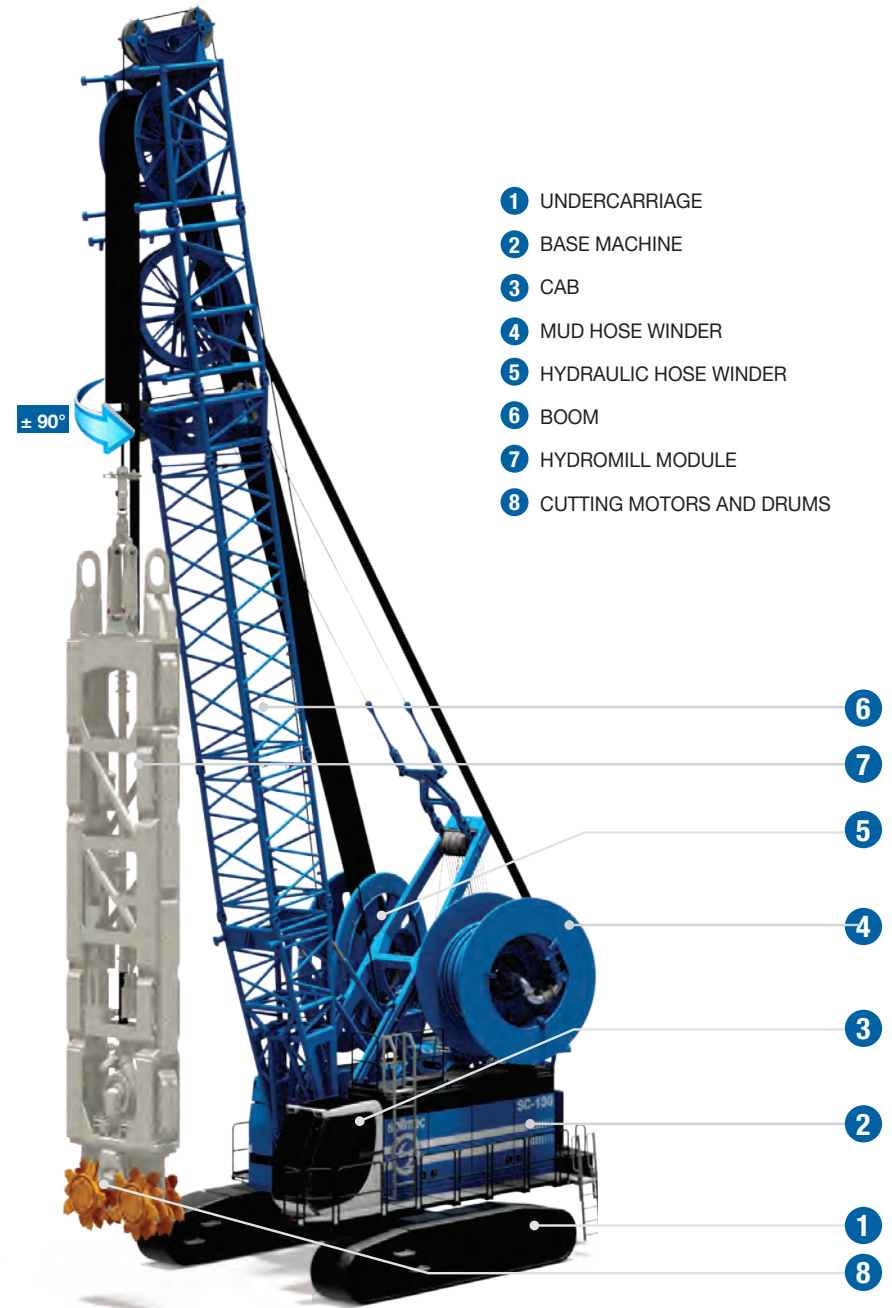
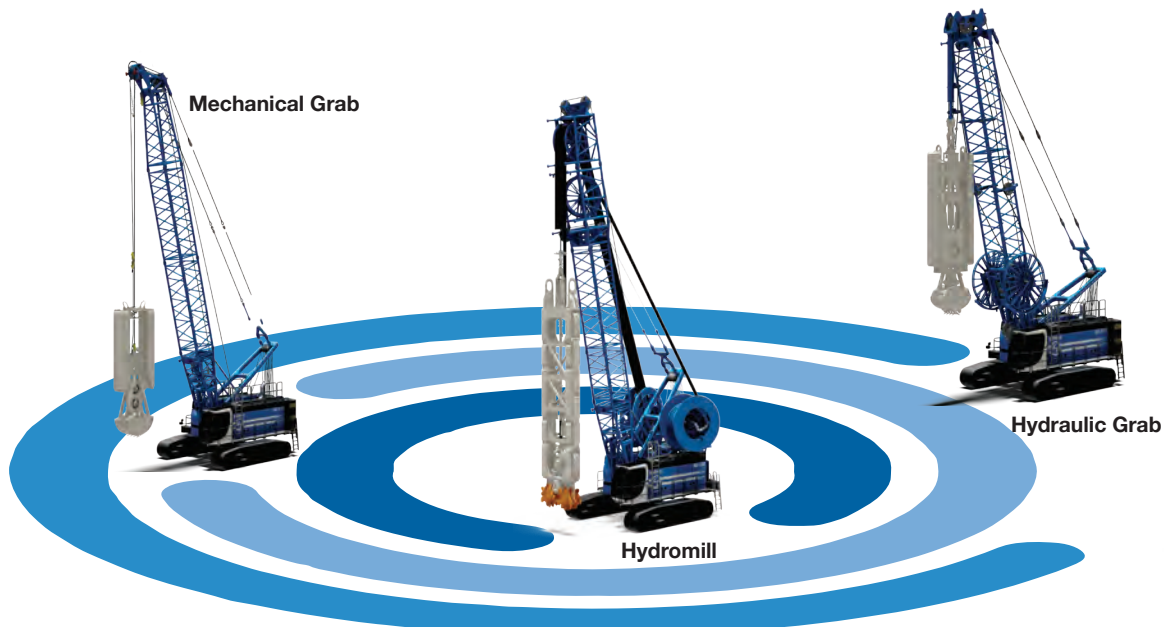



SC-130 "Tiger Plus"

Operating weight	185000 kg	407855 lb
Max cutting depth - <i>standard version</i>	80 m	262 ft
Max cutting depth - <i>extended version</i>	120 m	394 ft
Milling unit	SH-40 / SH-30	SH-40 / SH-30
Module rotation	± 90°	± 90°
Operating height	24,5 m	80 ft
Boom length	22 m	72 ft
Working radius	5900 - 6600 mm	232 - 260 in
Operating length (<i>tail - excavation center</i>)	11210 - 11910 mm	441 - 469 in
Counterweight	17000 kg	37479 lb
Hose reel for cutter hydraulic hoses		
Number of hydraulic lines	7 + 1 (reserve) x 1"1/2	7 + 1 (reserve) x 1"1/2
Max rope speed @ 1 st layer	30 m/min	98 ft/min
Drum diameter	1400 mm	55 in
Hose reel for mud hose		
Mud hose diameter	6"	6"

SC-130 "Tiger Plus" - Grab version

Operating weight	120000 kg	264554 lb
Max capacity duty cycle operation	53000 kg	116845 lb
Max grab weight	35000 kg	77162 lb
Boom length	11 - 35 m	36 - 115 ft

Module data sheet

Module SH-30

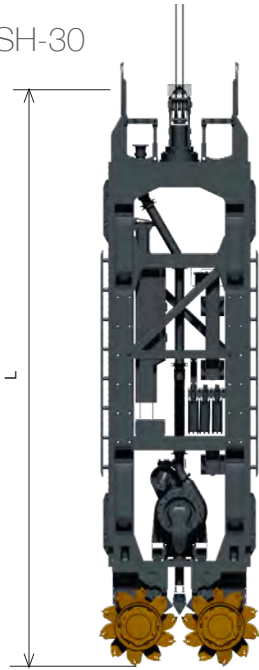

Module SH-40

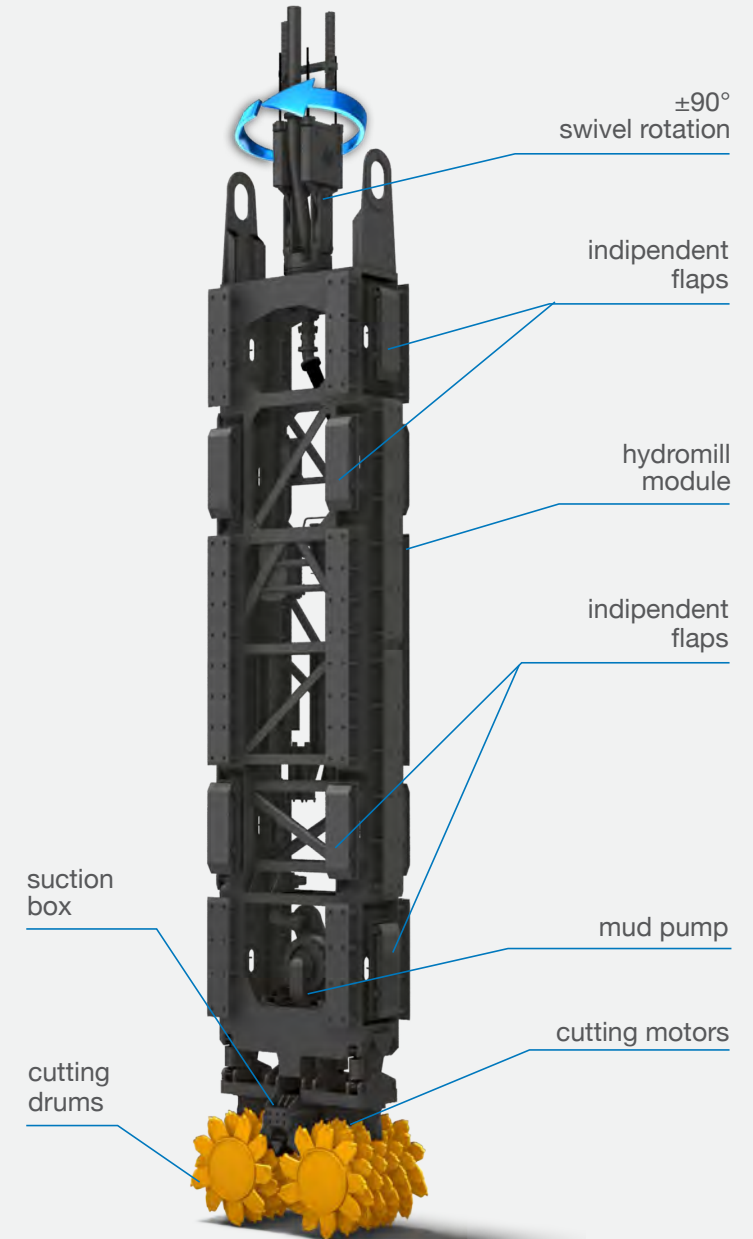
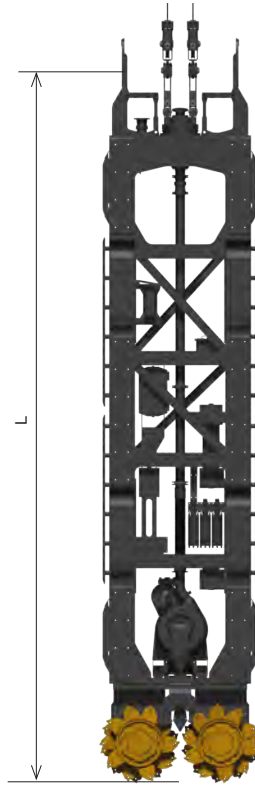

ModuleType	SH-30	SH-30	SH-40	SH-40
Hydromill module height (H)	10,5 m	34.5 ft	13 m	42.7 ft
Hydromill module length range (L)	2,6 - 3 m	8.5 - 9.8 ft	2,8 - 3,2 m	9.2 ft - 10.5 ft
Weight range	30 - 40 t	66139 - 88185 lb	40 - 50 t	88185 - 95883 lb
Independent mobile flaps	12	12	12	12
Cutting motors	2	2	2	2
Torque range	90 - 130 kNm	66381 - 95883 lbf*ft	90 - 150 kNm	66381 - 110634 lbf*ft
Drilling speed range	25 - 16 rpm	25 - 16 rpm	25 - 15 rpm	25 - 15 rpm
Mud pump power	170 kW	228 HP	170 kW	228 HP
Flow rate	450 m3/h	15891 ft3/h	450 m3/h	15891 ft3/h
Delivery pipe	152 mm	6 in	152 mm	6 in
Hydromill module rotation	+/- 90°	+/- 90°	+/- 90°	+/- 90°

Cutting drums

Standard Teeth Drums



Standard Teeth Drums

Coarse and cohesive soil, alluvial soil with small size of soft rocks boulders, medium-soft decompressed rocks (10 MPa UCS)

HD Teeth Drums



HD Teeth Drums

Mixed soils, fractured and medium decompressed rocks (20 MPa UCS)

Standard Pick Drums



Standard Pick Drums

Mixed soils with boulders, fractured and medium-hard decompressed rocks (20-50 MPa UCS)

Auger Pick Drums



Auger Pick Drums

Low fractured medium and hard rock formation (30-100 MPa UCS)

HD Pick Drums

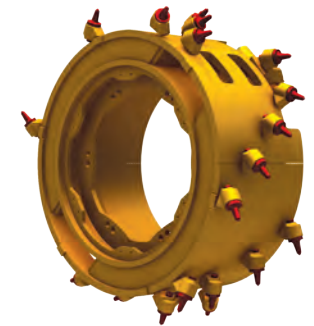

HD Pick Drums

Not fractured hard-extremely hard rock formation (50-300 MPa UCS)

Cutting motors

Production rates by soils

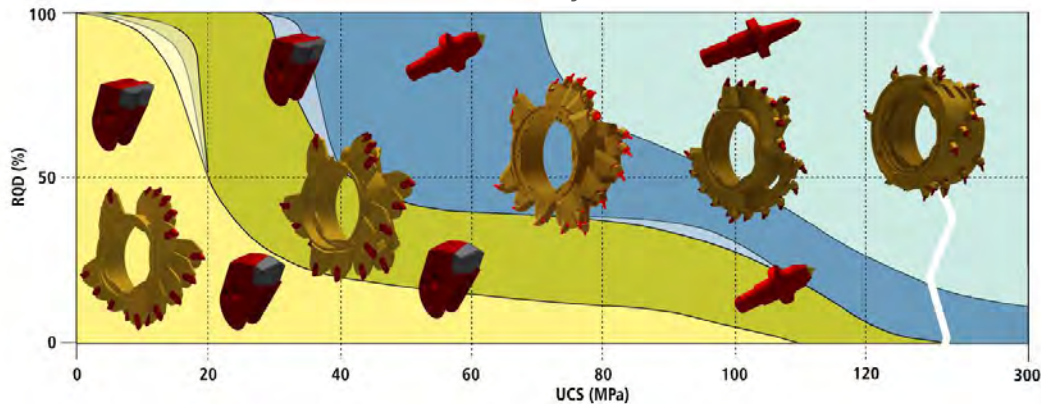

Cutting motors	Rated torque		Drilling speed	
H-9	90 kNm	66381 lbf*ft	25 rpm	25 rpm
HH-11	110 kNm	81132 lbf*ft	20 rpm	20 rpm
HH-13	130 kNm	95883 lbf*ft	16 rpm	16 rpm
HH-15	150 kNm	110634 lbf*ft	15 rpm	15 rpm

Cutting motors	800 mm 31.5 in	1000 mm 39.4 in	1200 mm 47.2 in	1500 mm 59.1 in	1800 mm 70.9 in
H-9	■	■	■	■	
HH-11		■	■	■	■
HH-13/15				■	■

Transport

Dimensions and Weights

Base machine (SC-39 VW undercarriage) c/w crawlers

Weight "Cougar" / "Tiger Plus"	78000 / 80000 kg	171960 / 176370 lb
Width	4000 mm	157 in
Height "Cougar" / "Tiger Plus"	4020 / 4090 mm	158 / 161 in
Length	12633 mm	497 in

Base machine (SC-39 VW undercarriage) w/o crawlers

Weight	57000 kg	125663 lb
Width	3500 mm	138 in
Height	3560 mm	140 in
Length	12633 mm	497 in

Base machine (SC-37 FW undercarriage) w/o crawlers

Weight "Cougar" / "Tiger Plus"	49500 / 49000 kg	109129 / 108026 lb
Width	3480 mm	137 in
Height "Cougar" / "Tiger Plus"	3620 mm	143 in
Length	12633 mm	497 in

Boom transport

Width	1685 mm	66 in
Weight - 3 m (10 ft)	1000 kg	2205 lb
Weight - 6 m (20 ft)	1600 kg	3527 lb
Weight - 9 m (30 ft)	2150 kg	4740 lb

Guide frame

Weight	2100 kg	4630 lb
---------------	----------------	----------------

Counterweight transport

Base width	1125 mm	44 in
Base weight	17000 kg	37479 lb
Block width	996 mm	39 in
Block weight	1550 kg	3417 lb

Sideframe transport

Weight	14000 kg	30865 lb
Width	1000 mm	39 in

"Tiger Plus"

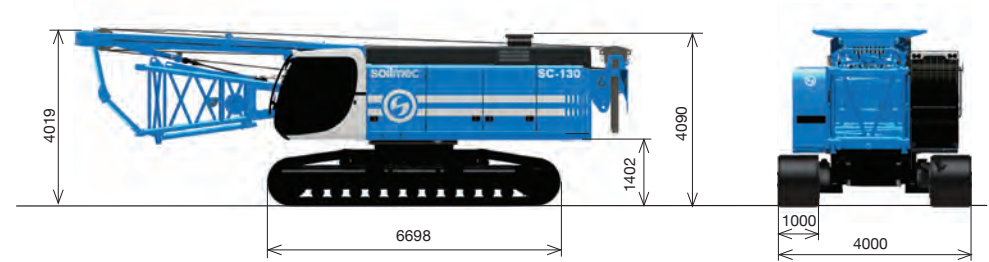

"Cougar"

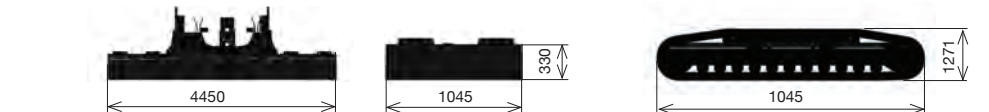
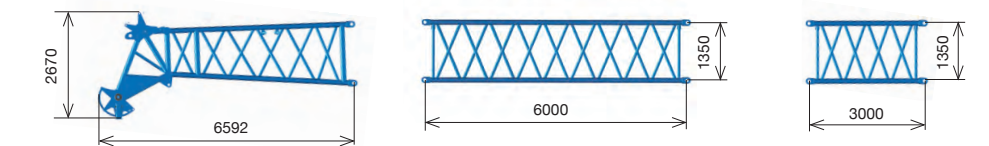
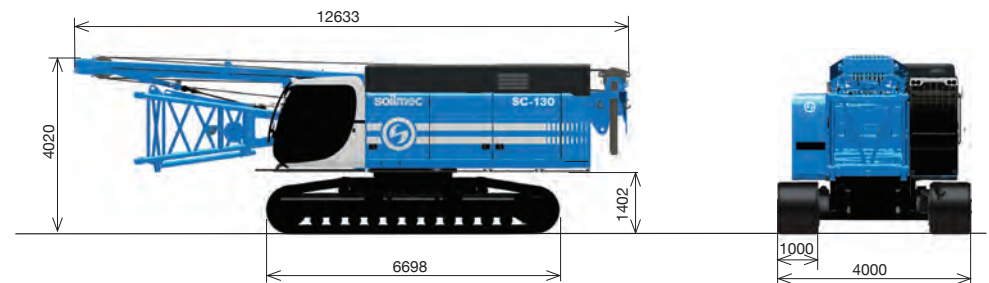
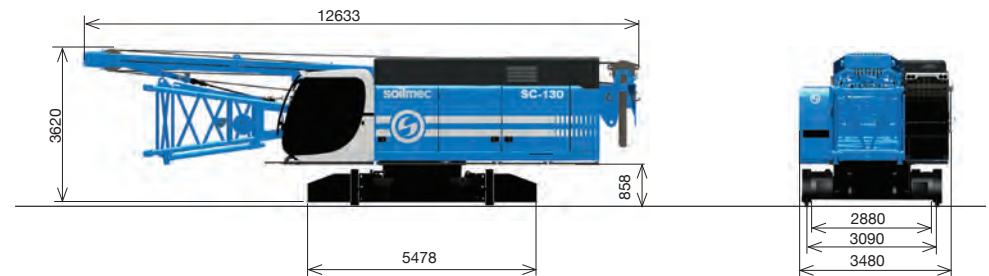

Cougar

Cathead		
Dimension	3550 x 2410 x 1815 mm	140 x 95 x 71 in
Weight	1800 kg	3968 lb
Boom tip		
Dimension	6000 x 2700 x 1650 mm	236 x 106 x 65 in
Weight	3600 kg	7937 lb
Hose guide wheels		
Dimension	2870 x 2050 x 700 mm	113 x 81 x 28 in
Weight	690 kg	1521 lb
Tensioning winch support frame		
Dimension	4240 x 1960 x 1100 mm	167 x 77 x 43 in
Weight	2700 kg	5952 lb
Housing for hydraulic hoses		
Dimension	3000 x 670 x 1230 mm	118 x 26 x 48 in
Weight	500 kg	1102 lb
Block		
Dimension	1865 x 825 x 440 mm	73 x 32 x 17 in
Weight	800 kg	1764 lb

Tiger Plus

Cathead		
Dimension	3705 x 2155 x 1578 mm	146 x 85 x 62 in
Weight	2300 kg	5071 lb
Hydraulic hoses drum		
Dimension	4500 x 3496 x 2500 mm	177 x 138 x 98 in
Weight	16000 ÷ 21000* kg	35274 ÷ 46297* lb
Mud hose drum		
Dimension	3500 x 3456 x 2500 mm	138 x 136 x 98 in
Weight	10000 ÷ 11500 *kg	22046 ÷ 25353* lb
Cathead for mud hose		
Dimension	3390 x 3468 x 2500 mm	133 x 137 x 98 in
Weight	2000 kg	4409 lb
Cathead for hydraulic hoses		
Dimension	4062 x 3188 x 2150 mm	160 x 126 x 85 in
Weight	2700 kg	5952 lb

* for 120 m depth version

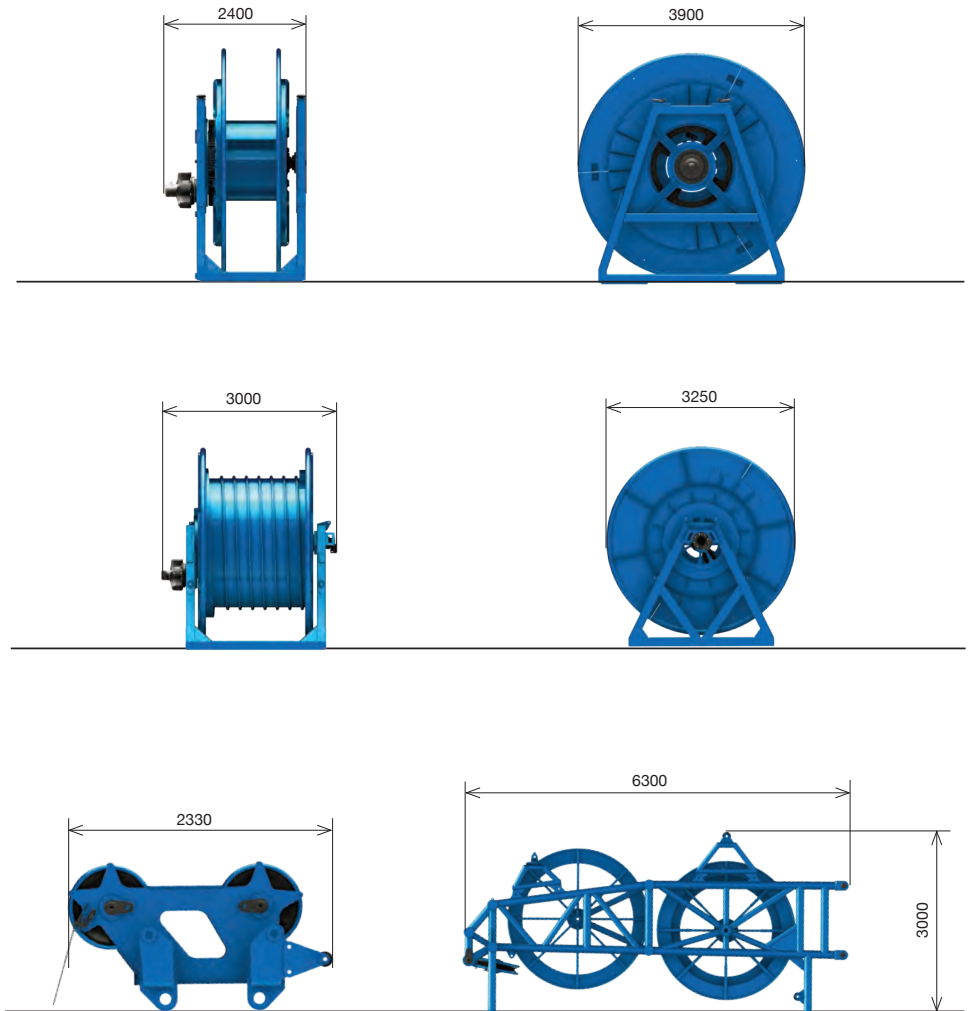

Technical data

Engine



Engine		
Model	CAT C18	<i>CAT C18</i>
Power rating	563 kW @ 1800 rpm	<i>755 HP @ 1800 rpm</i>
Engine conforms to Exhaust emission Standard	EU Stage V US EPA Tier 4f	<i>EU Stage V US EPA Tier 4f</i>
Fuel tank capacity	1100 l	<i>291 US gal</i>

Available: Engine Tier 2: Power rating 570 kW (764HP) @ 1800 rpm

Hydraulic system



Hydraulic system		
<i>Cougar</i>		
Main pums max oil flow	2 x 434 + 384 l/min	<i>2 x 115 + 101 US gal</i>
Hydraulic oil tank capacity	1250 l	<i>330 US gal</i>

Hydraulic system		
<i>Tiger Plus</i>		
Main pums max oil flow (tramming/cutter)	2 x 420 l/min	<i>2 x 111 US gal</i>
Main pums max oil flow (winches)	2 x 384 l/min	<i>2 x 101 US gal</i>
Hydraulic oil tank capacity	1250 l	<i>330 US gal</i>

Winches

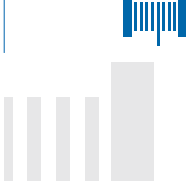

Main winch		
<i>Cougar</i>		
Type	Controlled descent	<i>Controlled descent</i>
1st layer line pull (nominal)	350 kN	<i>78682 lbf</i>
1st layer rope speed (max)	33 m/min	<i>108 ft/min</i>
Rope diameter	36 mm	<i>1.4 in</i>
Rope layers	3	<i>3</i>
Useful rope length with 1 / 2 / 3 full layers	39 / 90 / 144 m	<i>128 / 295 / 472 ft</i>

Two main winches		
<i>Tiger Plus</i>		
Type	Free fall	<i>Free fall</i>
1st layer line pull (nominal)	350 kN	<i>78682 lbf</i>
1st layer rope speed (max)	62 m/min	<i>203 ft/min</i>
Rope diameter	36 mm	<i>1.4 in</i>
Rope layers	3	<i>3</i>
Useful rope length with 1 / 2 / 3 full layers	39 / 90 / 144 m	<i>128 / 295 / 472 ft</i>

Undercarriage



Especially designed for heavy duty applications that require less penetration, better turning capability and less ground disturbance. Maintenance-free crawler track. Hydraulic chain tensioning device.

Undercarriage		
Type	Variable gauge	<i>Variable gauge</i>
Overall width extended	6000 mm	<i>236 in</i>
Overall width retracted	4000 mm	<i>157 in</i>
Overall length	6700 mm	<i>264 in</i>
Track shoes width	1000 mm	<i>39 in</i>
Track shoes type	Triple grouser	<i>Triple grouser</i>
Travel speed	0,8 - 1,6 km/h	<i>0.5 - 1.0 mph</i>
Traction force	722 kN	<i>162309 lbf</i>
Average ground pressure	0,21 MPa	<i>29 psi</i>

Available: Fixed gauge undercarriage with removable sides

Upper structure



Upper structure		
Turret width	3500 mm	<i>138 in</i>
Max slewing speed *	3.5 rpm	<i>3.5 rpm</i>
Swing tail radius	5310 mm	<i>209 in</i>

* selected for 3 speed range to increase speed precision (1 rpm max for Cougar)



Noise	Cougar	Tiger Plus
Sound pressure level in cab c/w Tier 4f Engine	77 dB(A)	77 dB(A)
Sound power level & sound pressure level c/w Tier 4f Engine	107 dB(A)	109 dB(A)

Cab



By assessing the specific application and listening properly to the wishes and requirements of the operators, Soilmec provides the optimal operator cabin for comfort.

Ergonomic seat with air suspension, fully adjustable, lumbar support, air management, as well as lines of sight, quality and safety are standard aspects considered during the design of the right configuration for the cabin. Cabin width 1050 mm 3.4 ft - Sliding door - Courtesy lights - Air conditioning system and climate control unit - Radio player with USB aux port.



DMS control system, developed and manufactured by Soilmec - is designed to give you a total control over performance, production and all your drilling rigs. In real time all the information relating to the operation work cycles and diagnostics of faults are shown on a multi language touch screen display installed in the cab. All drilling operations are actuated by two innovative joysticks. Automatic controls of rotary head and drilling phases are available on request thanks to simple implementation of our DMS system.

Configurations

	Cougar	Tiger Plus
UNDERCARRIAGE		
Triple grouser track shoes	●	●
Flat track shoes	○	○
Variable gauge undercarriage	●	●
Self-lifting kit for variable gauge undercarriage	○	○
Fixed gauge undercarriage	○	○
Extension kit for undercarriage fixed Gauge	○	○
4 access points with steps	●	●
Removable sides for low transport weight	○	○
Extension plates groups for undercarriage stabilizers	○	○
UPPER STRUCTURE		
Diesel engine Cat C18 Tier 4F / Stage V	●	●
Diesel engine Cat C18 Tier 2	○	○
Electro-proportional control system	●	●
360° access with 2 ladders for upper structure	●	●
Slew bearing with 3 roller bearings	●	●
Additional counterweight 6,2 t (6.8 US ton)	○	○
Free fall winches 35 t (39 US ton)	n.a.	●
Controlled descent winches 35 t (39 US ton)	●	n.a.
Limit switch for rope winding and winches	●	●
Quick assembly catwalk 900 mm width with handrails	●	●
Acoustic & light alarm for tramming	●	●
Automatic greasing kit	○	○
2° (Additional) Motoreducer for turret swing	n.a.	○
Service winch for assembling operation	○	○
Support for tools, air compressor and high pressure water pump	○	○
CAB		
Falling object protective structure (FOPS)	●	●
Rearview mirrors	●	●
Operator seat (air suspension, lumbar support, fully adjustable positioning, safety belt)	●	●
Sliding door	●	●
Sliding window	●	●
Lighting system in front of the cab	●	●
Sunshade shield for cabin	○	○

	Cougar	Tiger Plus
CONTROL AND MONITORING SYSTEM		
DMS ON BOARD with control of machine performance and excavation parameters	●	●
DMS PC for production data analysis and report	○	○
GSM / GPRS / WIFI Modem	●	●
DMS manager 4.0	●	●
Adjustable monitor 12" touch screen	●	●
SAFETY		
6 video-cameras	●	●
Assembly mode for rigging/de-rigging	●	●
Control board for rope changing	●	●
Radio remote control for assembly	●	●
High led lighting system	●	●
Safety life line on the boom and base boom ladder	○	○
BOOM		
Boom extension 3 - 6 - 9 m (10 - 20 - 30 ft)	●	●
Boom angle available on display	●	●
Working radius available on display	●	●
Max handling load available on display	n.a.	●
Current handling load available on display	n.a.	●
DIAPHRAGM WALL TECHNOLOGY		
High pressure filters	●	●
Drain tank with hydro-clean micro filtration and water separation	●	●
Hose set (hydraulic and mud) for 52 m depth	●	n.a.
Hose set (hydraulic and mud) for 70 m depth	○	n.a.
Hose set (hydraulic and mud) for 80 m depth	n.a.	●
Hose set (hydraulic and mud) for 120 m depth	n.a.	○
Mud flow-meter	○	○
Remote control board for teeth changing	●	●
DMS PC 3D option for panels overlap control	○	○
Warning alarm in case of hydraulic oil contamination	●	●
Hydraulic grab GH-15/GH-20	n.a.	○
Inclinometer c/w watertight box	●	●
Grab body extendable with additional side guides	n.a.	○
Interchangeable jaws and teeth	○	○

	Cougar	Tiger Plus
Depthmeter	●	●
Manual greasing	●	●
Hydromill module hydraulic drain	○	○
Mechanical grab GC-11/GC-16	n.a.	○
Automatic greasing	○	○

● standard ○ optional n.a. not available

A close-up photograph of a muddy tire tread on a dirt surface. The tire is on the left side of the frame, and the mud is dark brown and textured. The background is blurred, showing more of the dirt and a hint of a blue object.

www.soilmec.it

This brochure has been edited and distributed by SOILMEC Spa. The present document cancels and override any previous ones. This brochure shall not be distributed, reproduced or exhibited without SOILMEC Spa. authorization in accordance with to SOILMEC web site disclaimer condition.

SOILMEC Spa distributes machinery and structures all over the world, supported by SOILMEC Spa subsidiary companies and dealers. The complete Soilmec network list is available on the web site www.soilmec.it

#muddyboots